

Imperial [IP] Dimensions
Metric (SI) in Parentheses

CARNES COMPANY 448 S. Main St., P. O. Box 930040, Verona, WI 53593-0040 Phone: (608)845-6411 Fax: (608)845-6504 www.carnes.com

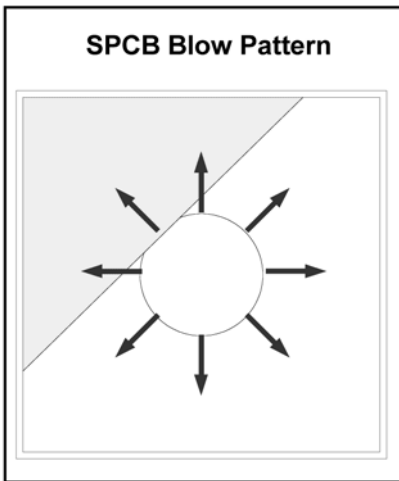
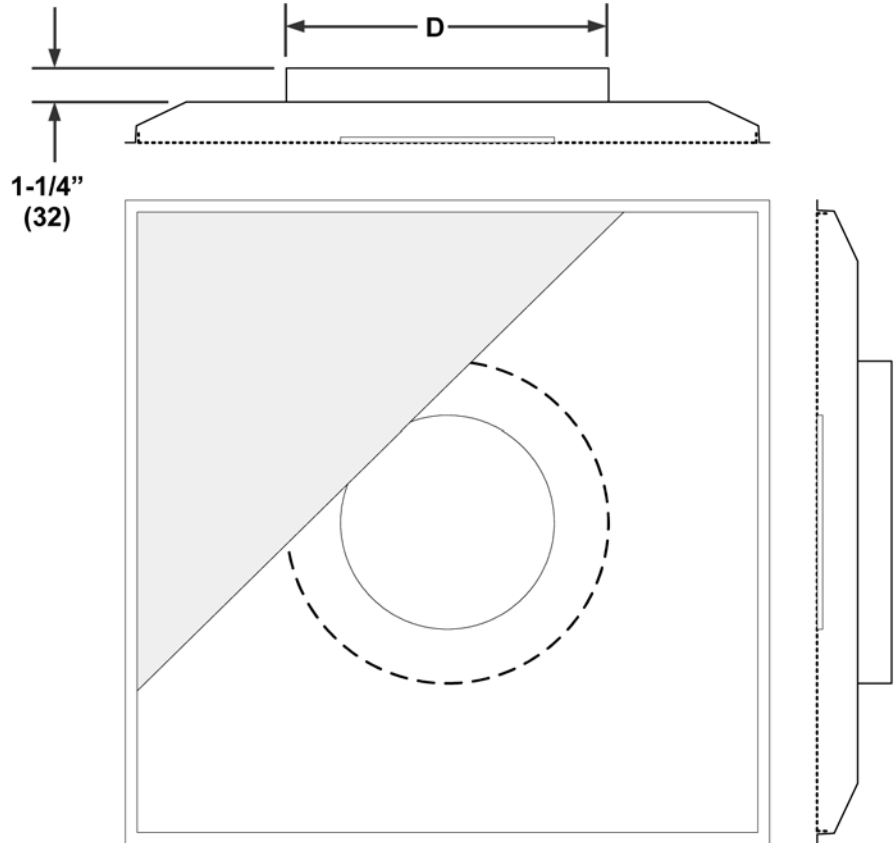
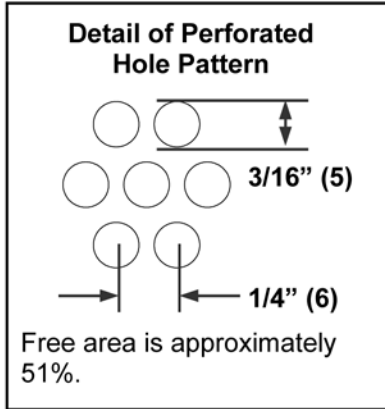

Notes:

- Construction of SPCB is steel ceiling plate and steel face plate.
- Model SPCB is available with an aluminum face plate as an option.
- Metric dimensions are given in millimeters.
- Standard finish is electrocoat acrylic baked enamel.
- Standard color is #11 Bright White.
- Inlet is undersized by 1/8" (3) to fit inside standard duct.
- 24" x 24" face T-bar frame (Frame 4) is shown above with standard face (Face C or A).

Nominal Face Size	Nominal Inlet Size	Inlet O.D. (D)
12" x 12" (305 x 305)	5" (127)	4-7/8" (124)
	6" (152)	5-7/8" (149)
	7" (178)	6-7/8" (175)
	8" (203)	7-7/8" (200)
24" x 24" (610 x 610)	5" (127)	4-7/8" (124)
	6" (152)	5-7/8" (149)
	7" (178)	6-7/8" (175)
	8" (203)	7-7/8" (200)
	10" (254)	9-7/8" (251)
	12" (305)	11-7/8" (302)
	14" (356)	13-7/8" (352)
	16" (406)	15-7/8" (403)
18" (457)	17-7/8" (454)	

Imperial [IP] Dimensions
Metric (SI) in Parentheses

CARNES COMPANY 448 S. Main St., P. O. Box 930040, Verona, WI 53593-0040 Phone: (608)845-6411 Fax: (608)845-6504 www.carnes.com

Standard T-Bar Mount

Frame 4

Standard Face C (Steel) or A (Aluminum)

- Fits 15/16" and 9/16" flat-face T-bar.
- Use with KXFA Auxiliary Frame for surface mount applications.

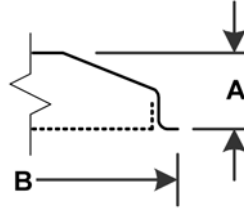

Nom. Face	12" x 12"	24" x 24"
Unit Height (A)	1-1/4" (32)	1-1/2" (38)
Unit Width (B)	11-3/4" (298)	23-3/4" (603)

15/16" Tegular Mount

Frame 4

Drop Face D (Steel) or B (Aluminum)

- Fits 15/16" and 9/16" flat-face T-bar.
- Fits 15/16" tegular ceilings.
- Use with KXFA Auxiliary Frame for surface mount applications.

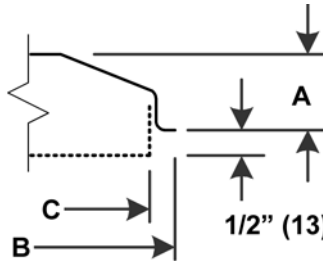

Nom. Face	12" x 12"	24" x 24"
Unit Height (A)	1-1/4" (32)	1-1/2" (38)
Unit Width (B)	11-3/4" (298)	23-3/4" (603)
Face Width (C)	11" (279)	23" (584)

Surface Mount

Frame 2

Flush Face C (Steel) or A (Aluminum)

- For use with hard duct or special mounting by contractor.

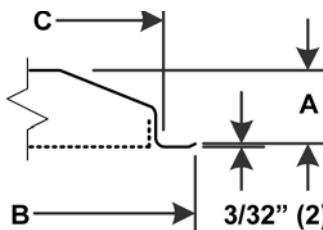

Nom. Face	12" x 12"	24" x 24"
Unit Height (A)	1-3/16" (30)	1-7/16" (37)
Unit Width (B)	12-1/2" (318)	24-1/2" (622)
Rec. Ceiling Opening (C)	11" (279)	23" (584)

Surface Mount with Drop Face

Frame 2

Drop Face D (Steel) or B (Aluminum)

- For use with hard duct or special mounting by contractor.
- Face projects 1/2" (13) below ceiling plate.

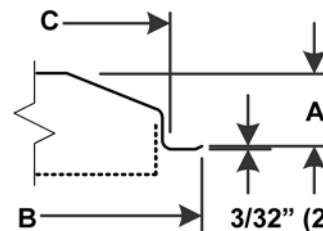

Nom. Face	12" x 12"	24" x 24"
Unit Height (A)	1-3/16" (30)	1-7/16" (37)
Unit Width (B)	12-1/2" (318)	24-1/2" (622)
Rec. Ceiling Opening (C)	11" (279)	23" (584)

Donn® Fineline® Style and 9/16" Tegular Mount

Frame 9

Standard Face C (Steel) or A (Aluminum)

- Fits Donn® Fineline® style ceilings.
- Fits 9/16" tegular ceilings.

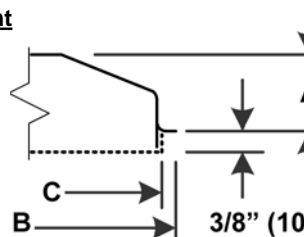

Nom. Face	12" x 12"	24" x 24"
Unit Height (A)	1-3/16" (30)	1-7/16" (37)
Unit Width (B)	11-3/4" (298)	23-3/4" (603)
Face Width (C)	11-1/4" (286)	23-1/4" (591)

Concealed Spline Mount

Frame 8

Standard Face C (Steel) or A (Aluminum)

- Fits concealed spline ceilings.
- Sliding pin locks ceiling plate to grid.
- Pin is concealed for architectural appeal.

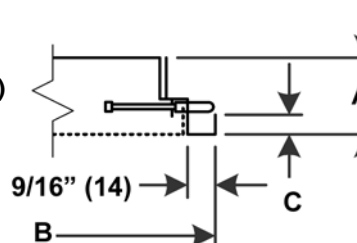

Nom. Face	12" x 12"	24" x 24"
Unit Height (A)	1-3/16" (30)	1-7/16" (37)
Unit Width (B)	11-31/32" (304)	23-31/32" (609)
Drop (C)	3/8" (10)	3/8" (10)