

Imperial [IP] Dimensions
Metric (SI) in Parentheses

CARNES COMPANY 448 S. Main St., P. O. Box 930040, Verona, WI 53593-0040 Phone: (608)845-6411 Fax: (608)845-6504 www.carnes.com

SQUARE

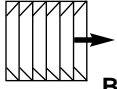

BLOW-10

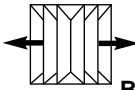

BLOW-20

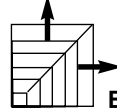

BLOW-25

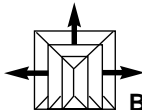

BLOW-30

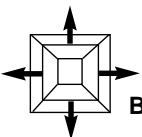

BLOW-40

RECTANGULAR

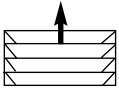

BLOW-11

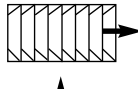

BLOW-12

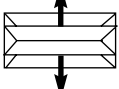

BLOW-21

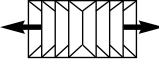

BLOW-22

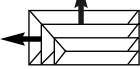

BLOW-26

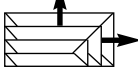

BLOW-27

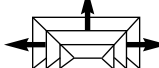

BLOW-31

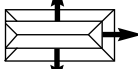

BLOW-32

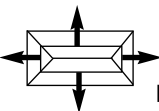

BLOW-41

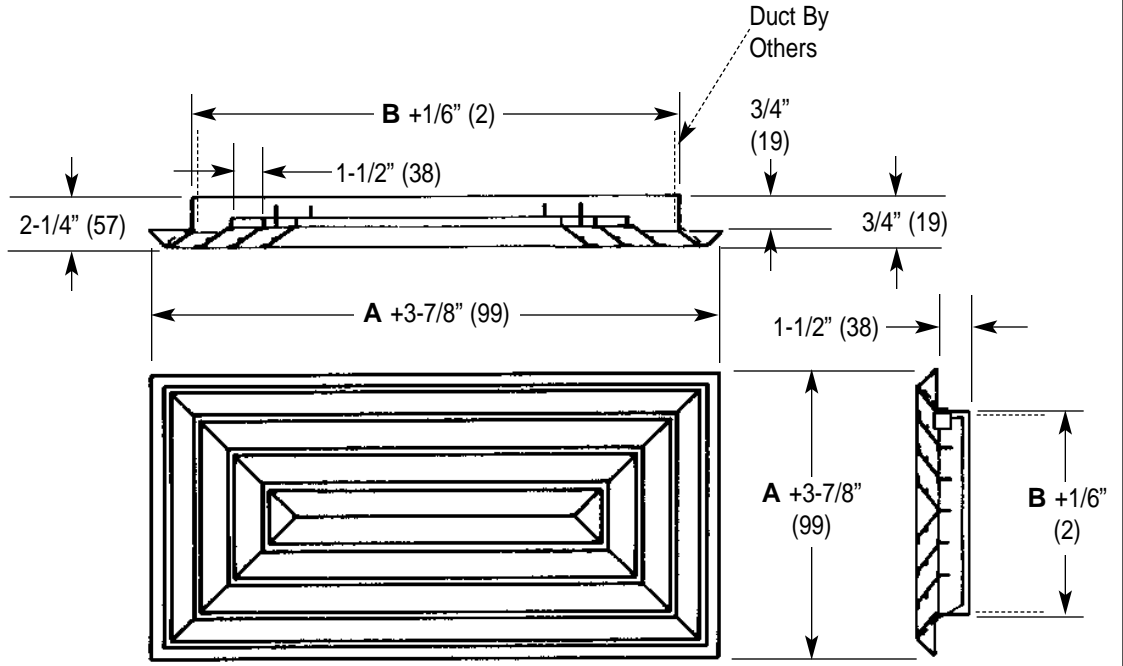

MINIMUM CEILING OPENING $A + 1"$ (25) and $B + 1"$ (25)

DIMENSIONS LISTED IN INCHES (Millimeters)

Size A x B	Panel C x D
6 x 6 (152 x 152)	12 x 12 (305 x 305)
6 x 9 (152 x 229)	12 x 15 (305 x 381)
6 x 12 (152 x 305)	12 x 18 (305 x 457)
6 x 15 (152 x 381)	12 x 21 (305 x 533)
6 x 18 (152 x 457)	15 x 15 (381 x 381)
6 x 21 (152 x 533)	15 x 18 (381 x 457)
9 x 9 (229 x 229)	15 x 21 (381 x 533)
9 x 12 (229 x 305)	18 x 18 (457 x 457)
9 x 15 (229 x 381)	18 x 21 (457 x 533)
9 x 18 (229 x 457)	21 x 21 (533 x 533)
9 x 21 (229 x 533)	24 x 24 (610 x 610)

Note: Standard finish is #11 Bright White.