

IP Units (SI Metric on Reverse)

CARNES COMPANY 448 S. Main St., P. O. Box 930040, Verona, WI 53593-0040 Phone: (608)845-6411 Fax: (608)845-6504 www.carnes.com

SQUARE

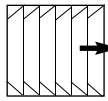

BLOW-10

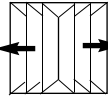

BLOW-20

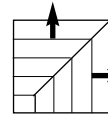

BLOW-25

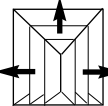

BLOW-30

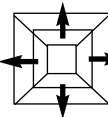

BLOW-40

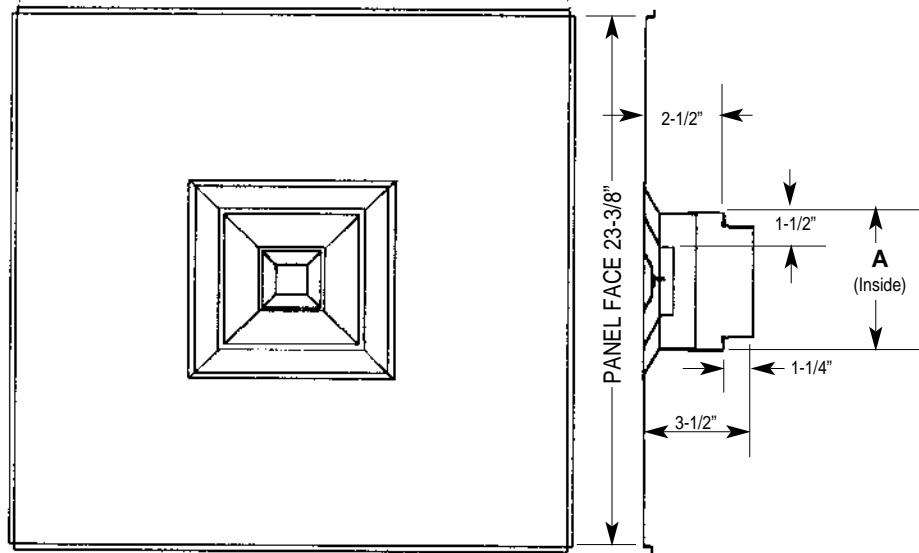
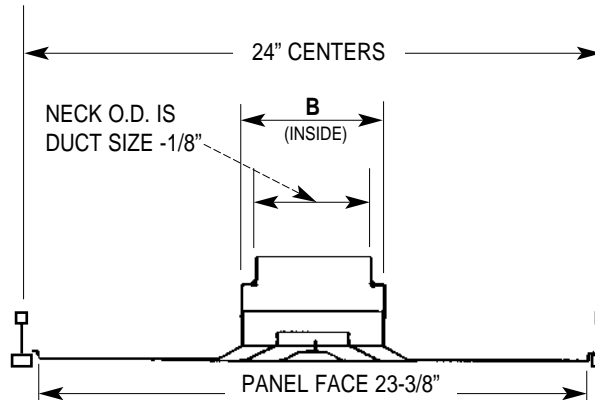
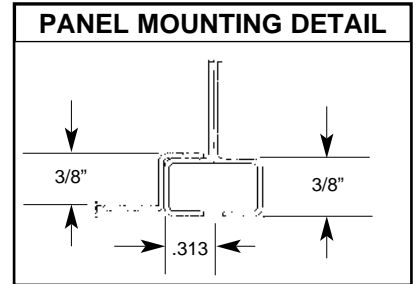

DIMENSIONS LISTED IN INCHES

Round Neck O. D.	A x B
4	6 x 6
5	6 x 6
6	6 x 6
6	9 x 9
8	9 x 9
9	9 x 9
10	12 x 12
12	12 x 12
12	15 x 15
14	15 x 15
15	15 x 15
16	18 x 18
18	18 x 18
20	21 x 21
21	21 x 21

"DONN" and "FINELINE" are registered trademarks of USG Interiors, Inc.

SI Metric Units (IP on Reverse)

CARNES COMPANY 448 S. Main St., P. O. Box 930040, Verona, WI 53593-0040 Phone: (608)845-6411 Fax: (608)845-6504 www.carnes.com

SQUARE

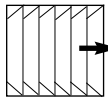

BLOW-10

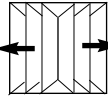

BLOW-20

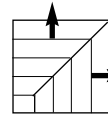

BLOW-25

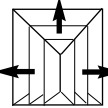

BLOW-30

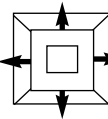

BLOW-40

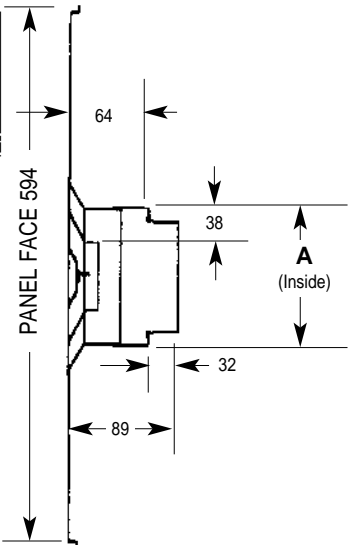
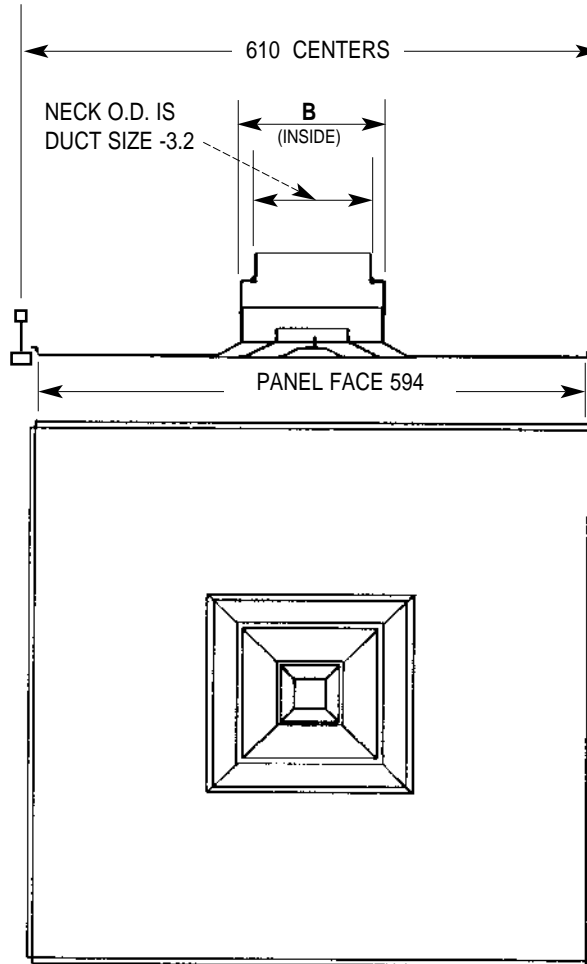
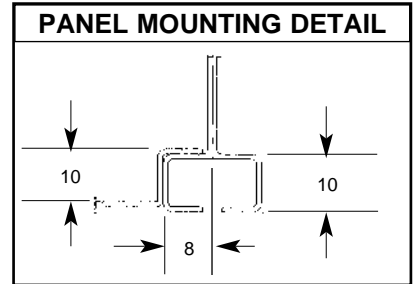

DIMENSIONS LISTED IN MILLIMETERS

Round Neck O. D.	A x B
102	152 x 152
127	152 x 152
152	152 x 152
152	229 x 229
203	229 x 229
229	229 x 229
254	305 x 305
305	305 x 305
305	381 x 381
356	381 x 381
381	381 x 381
406	457 x 457
457	457 x 457
508	533 x 533
533	533 x 533