

Models ACF w/o Coil
ACW w/Hot Water Coil
ACE w/Electric Coil

The **Carnes** constant volume fan terminal unit provides constant air volume to the space while retaining the advantages of a variable air volume system.

The primary air control assembly operates in the same manner as a standard throttling control valve when cooling loads are high. As cooling loads diminish the integral blower(s) induces warm ceiling plenum air to maintain constant air volume.

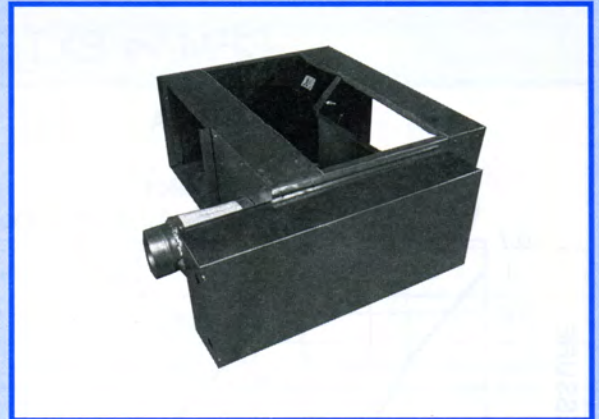

Other Features Include:

- Air flow capacities to 3700 CFM.
- Durable 22 gauge galvanized steel casing construction.
- Bottom access panel for internal components.
- Flange or slip and drive discharge connections.
- Forward curved centrifugal type fan assemblies with thermally protected, permanent split capacitor type 115 or 277 volt, single phase, fractional horsepower motors.
- Adjustable SCR fan speed control.
- Fan/motor assemblies are isolated from the casing using rubber isolators to minimize vibration transmission.
- Low leakage primary air damper design.
- Secondary air filter rack.
- Performance data based on tests conducted in accordance with ARI Standard 880-94.
- Air flow switch.
- All units are equipped with pressure independent pneumatic or electronic controls.
- Field adjustable P/E switch with pneumatic controls.
- Averaging type velocity sensor and calibration chart for measuring air flow through the primary air damper.
- Insulation is 1" thick, 1-1/2 lb. dual density fiberglass with surface treated to prevent air erosion, UL listed and meets NFPA 90A requirements.
- Damper controls and fan controls are located in one enclosure.
- ARI listed.
- Optional ETL listing.
- Optional secondary air sound baffle. Sound baffle is factory attached to secondary air inlet. (Contact Carnes)
- Optional one or two row hot water coils (Model ACW). Coil is factory attached to the unit discharge.
- Optional one, two or three stage electric reheat coils (Model ACE). Coil is factory attached to unit discharge or shipped separately for field mounting.
- Optional secondary air filters, Class I (re-usable) or Class II (throw away).
- Optional non-fused or fused fan disconnect switch.
- Optional foil coated insulation (Hospital, Laboratory, etc. applications).

Available Modules:

- Basic control unit — **Model ACF.**
- Basic control unit with hot water coil — **Model ACW.**
- Basic control unit with electric coil — **Model ACE.**

FAN CURVES

CFM vs EXTERNAL STATIC PRESSURE

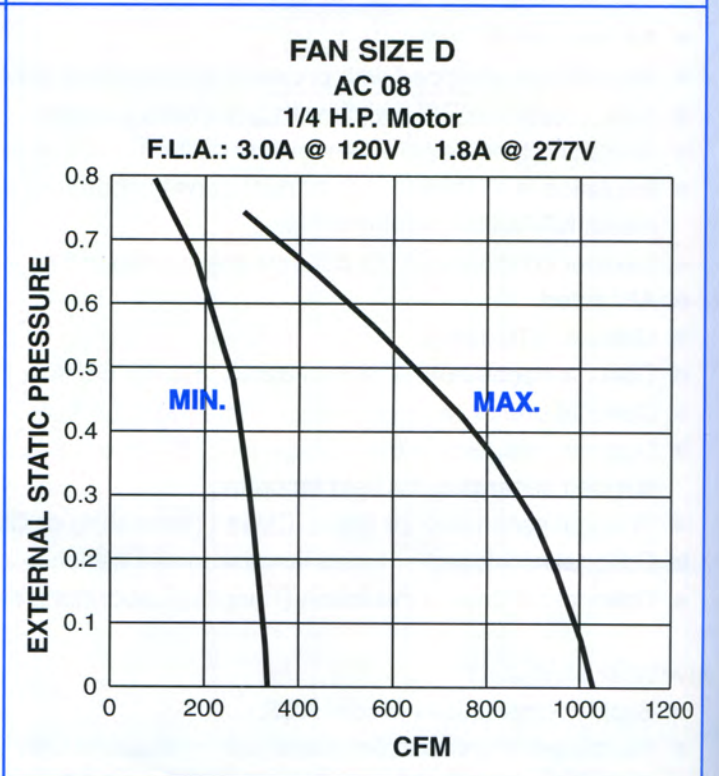
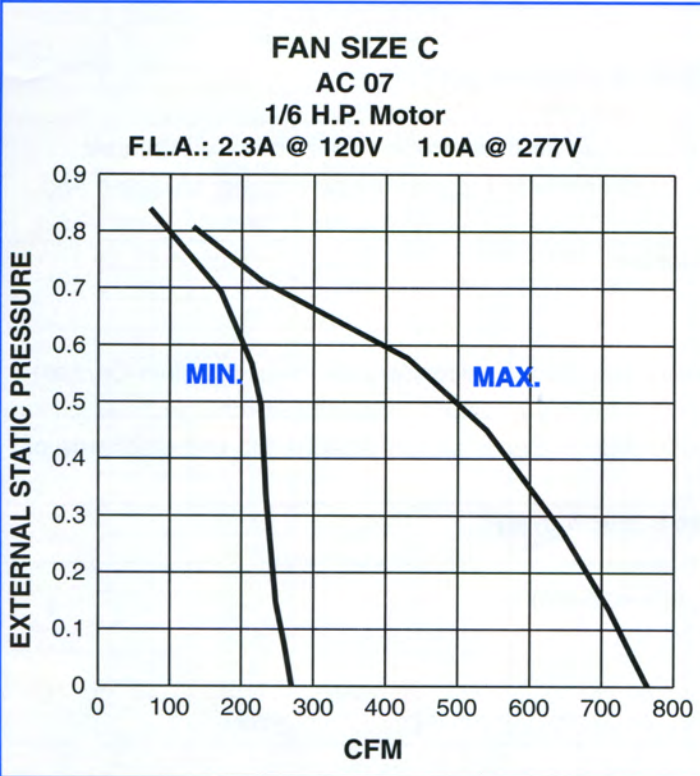
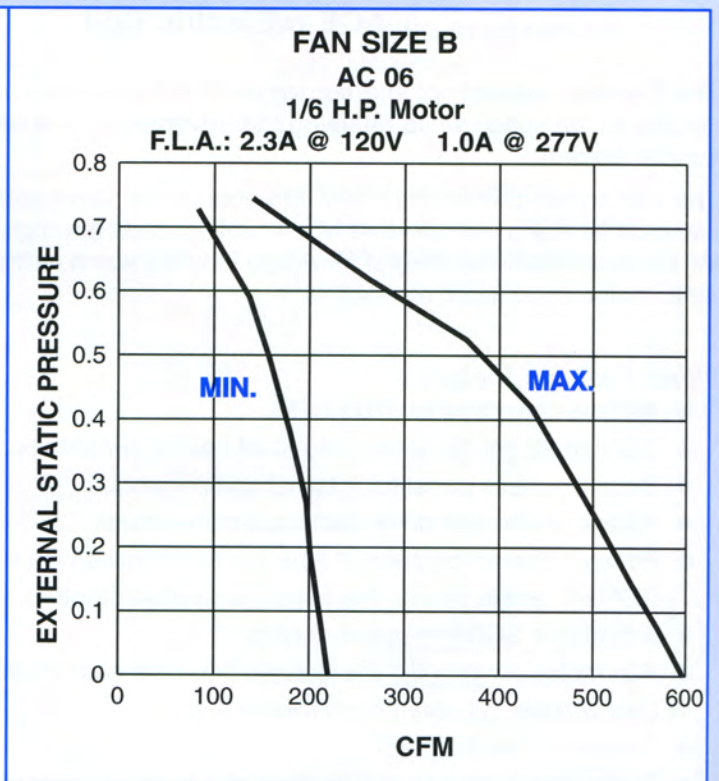
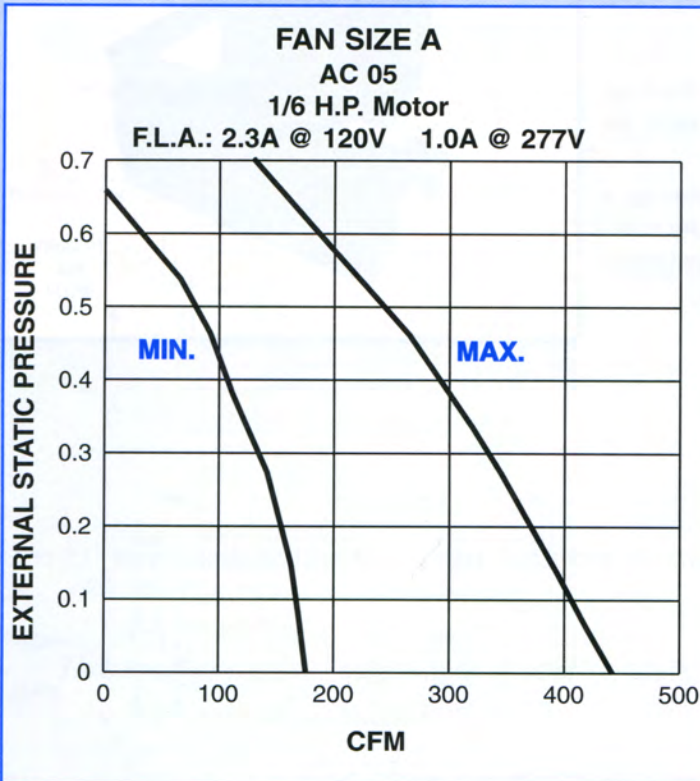

- NOTES:**
- External static pressure (ESP) consists of downstream ductwork, coils, flex duct, etc.
 - Pressure drops due to heating coils are treated as external static pressure (Refer to coil sections of this catalog for additional information).
 - F. L. A. = Full Load Amps of motor.
 - For proper operation, the downstream ESP must be at least 0.20" W. G.

FAN CURVES

CFM vs EXTERNAL STATIC PRESSURE

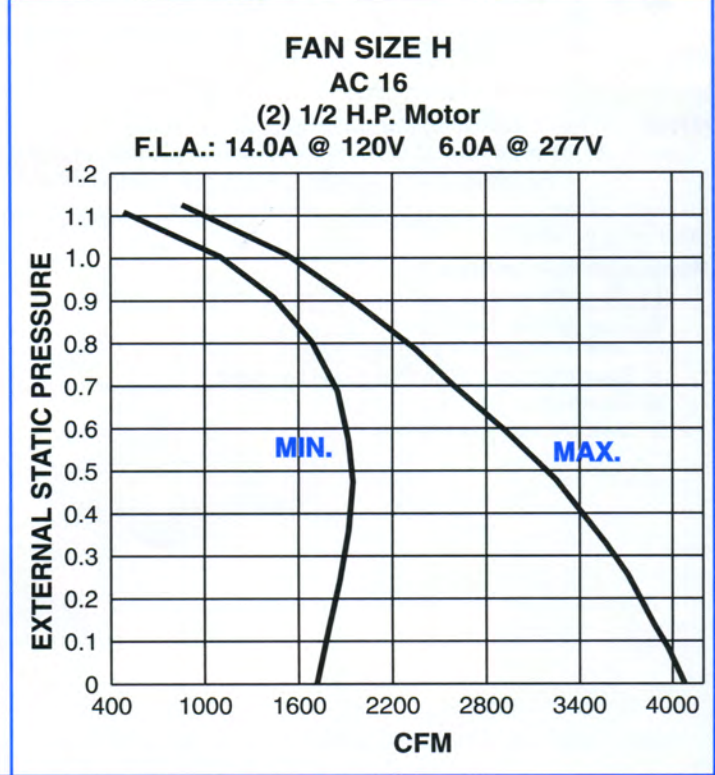
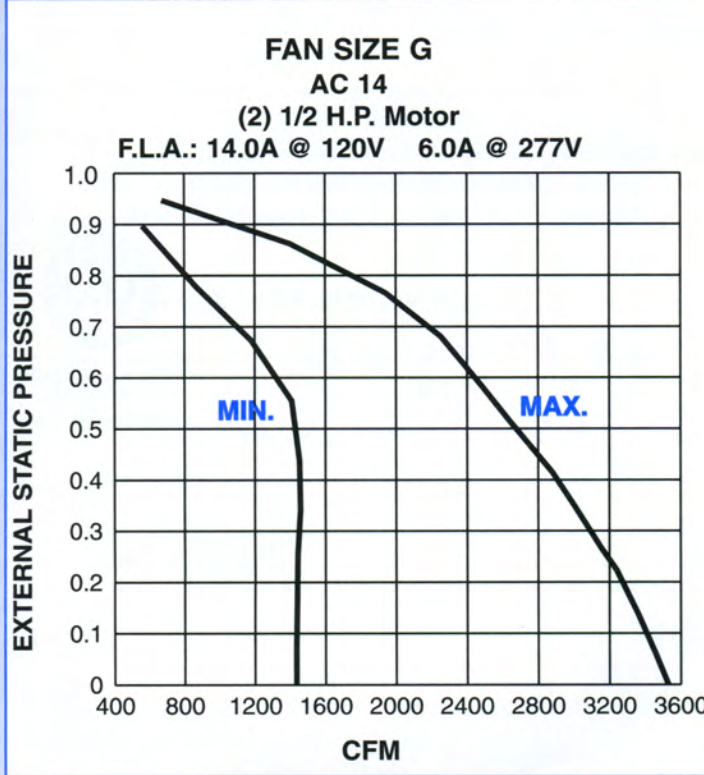
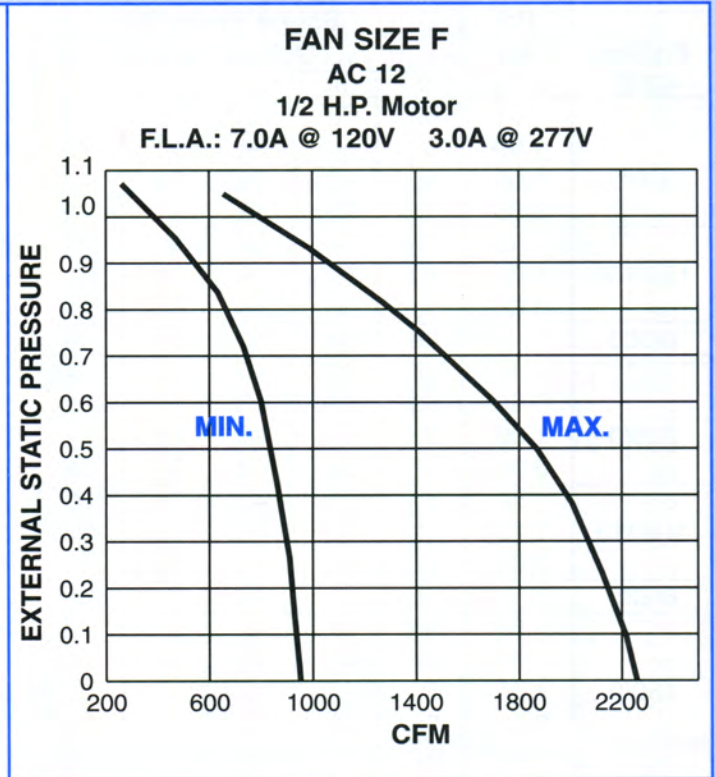
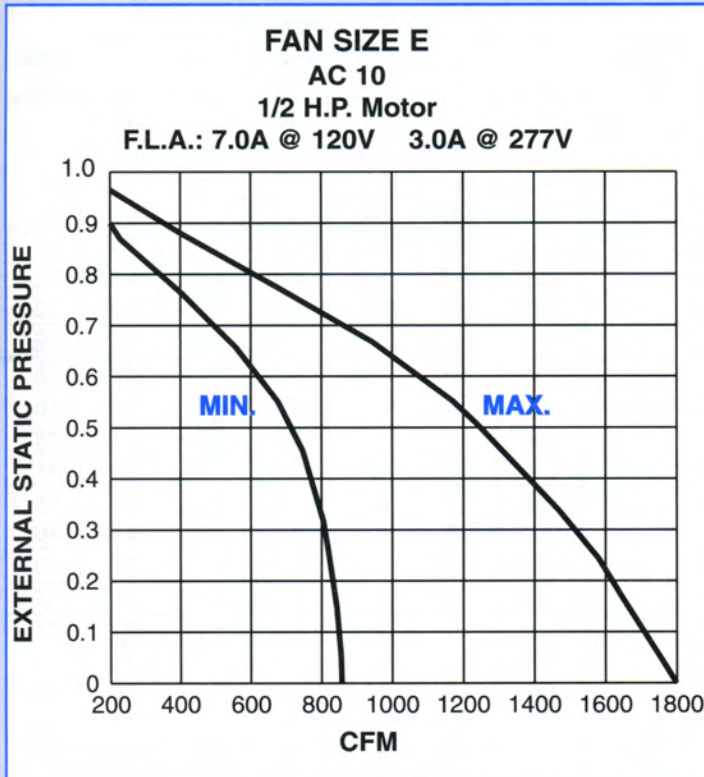

- NOTES:**
1. External static pressure (ESP) consists of downstream ductwork, coils, flex duct, etc.
 2. Pressure drops due to heating coils are treated as external static pressure (Refer to coil sections of this catalog for additional information).
 3. F. L. A. = Full Load Amps of motor.
 4. For proper operation, the downstream ESP must be at least 0.20" W. G.

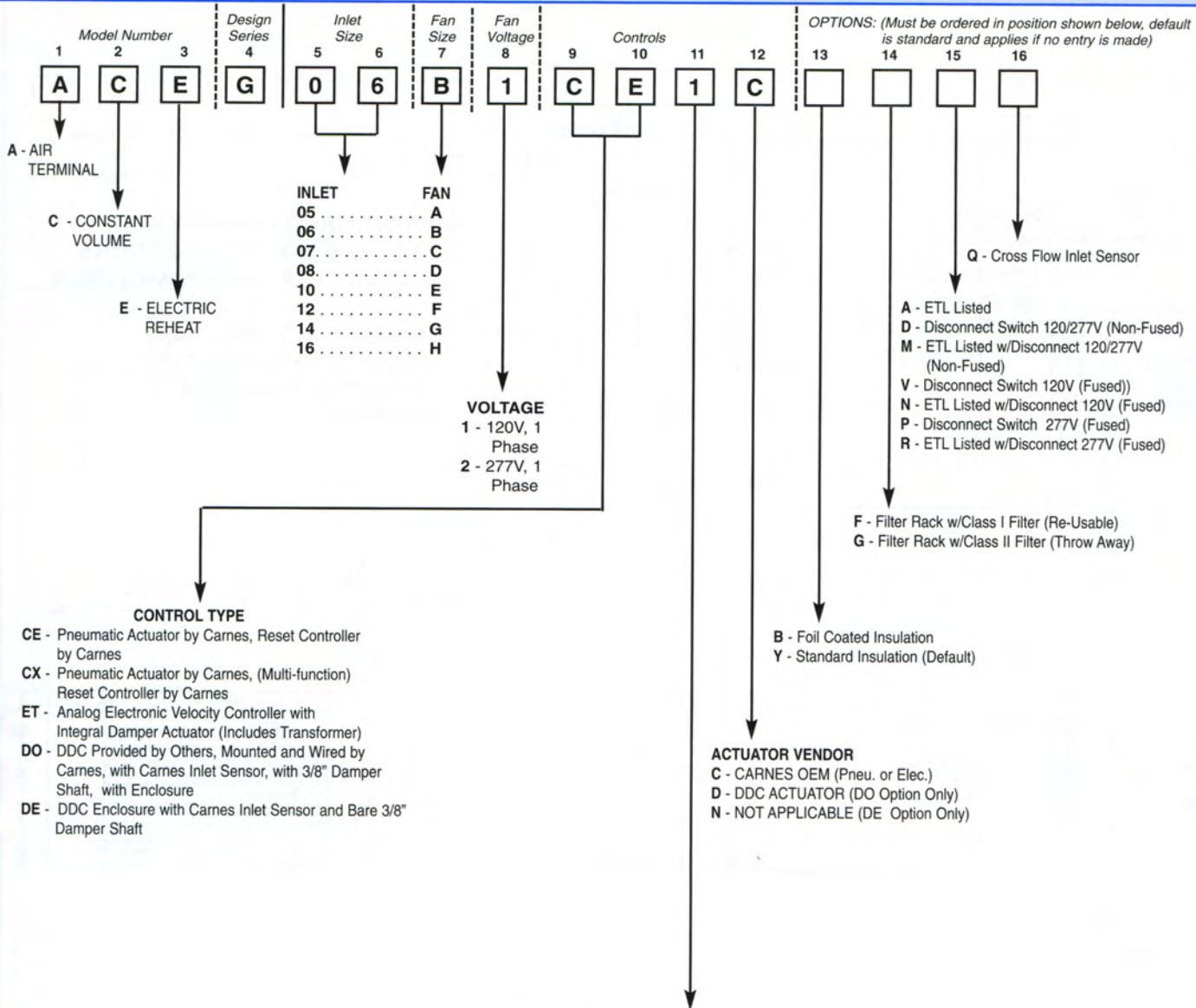

NOTE: Hand of controls is determined by facing the averaging flow sensor (inlet of the unit) with the supply air hitting the back of your head.

CONTROLS AND DAMPER ARRANGEMENT

- *1 - Normally Open - Right Hand Controls
(Electronic/DO, DE, ET)
(All Pneumatic Control Types for Reverse Acting Thermostat)
- *2 - Normally Open - Left Hand Controls
(Electronic/DO, DE, ET)
(All Pneumatic Control Types for Reverse Acting Thermostat)
- 3 - Normally Closed - Right Hand Controls
(All Pneumatic Control Types for Direct Acting Thermostat)
- 4 - Normally Closed - Left Hand Controls
(All Pneumatic Control Types for Direct Acting Thermostat)
- 5 - Normally Open - Right Hand Controls
(All Pneumatic Control Types for Direct Acting Thermostat)
- 6 - Normally Open - Left Hand Controls
(All Pneumatic Control Types for Direct Acting Thermostat)
- 7 - Normally Closed - Right Hand Controls
(All Pneumatic Control Types for Reverse Acting Thermostat)
- 8 - Normally Closed - Left Hand Controls
(All Pneumatic Control Types for Reverse Acting Thermostat)

A Carnes Electronic Thermostat **must be ordered** with the Electronic ET Control Option.

"Electronic and DDC Units DO NOT Fail Open. "1" or "2" is used for Model Numbering Only. Electronic Units are shipped with the Damper in Closed Position. (Refer to the Controls Catalog AV-02 for additional operating information.)

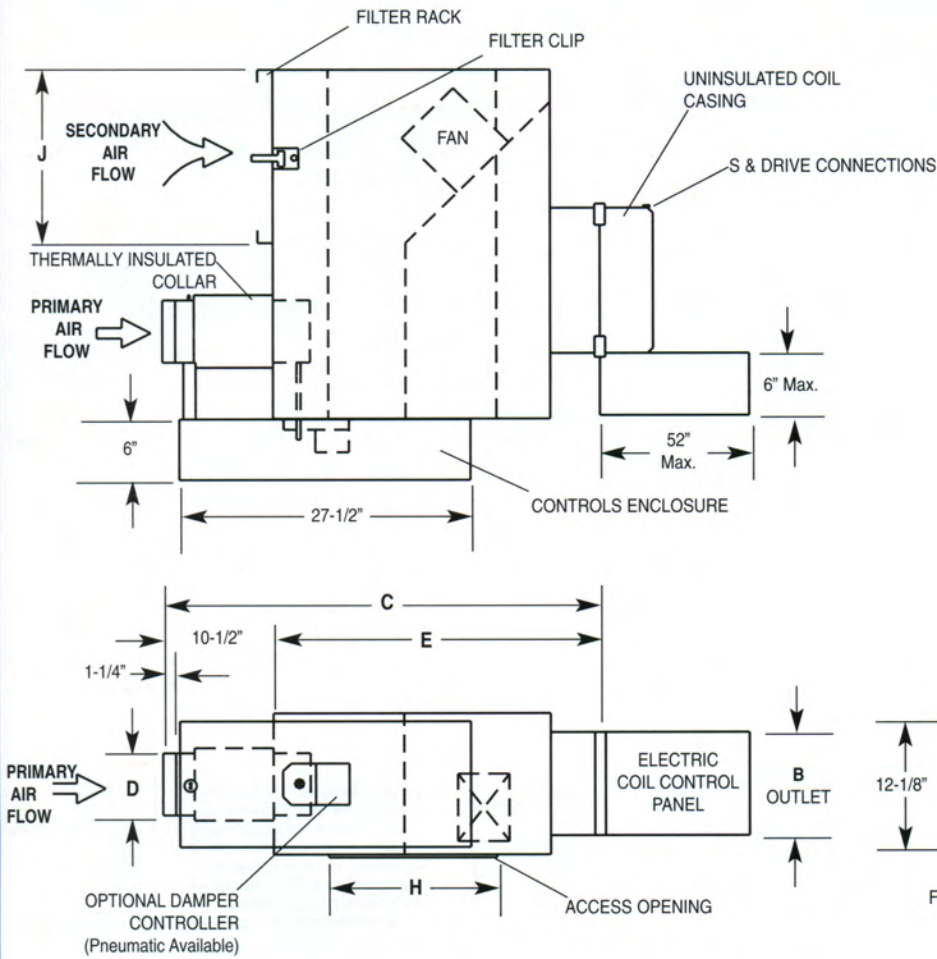

— RIGHT HAND PRIMARY AIR UNIT SHOWN. LEFT HAND AVAILABLE.

— PRIMARY AIR AND COIL CONTROL PANEL MUST BE LOCATED ON SAME SIDE OF UNIT.

DIMENSIONS LISTED IN INCHES

Fan Size	Inlet Size	Primary Nominal CFM	Secondary Nominal CFM @ .25" E.S.P.	Fan H.P.	Outlet		C	D	E	G	H	J	K
					A	B							
A	05	350	300	1/6	14	10	41-7/16	4-7/8	30-15/16	33-3/4	17-13/16	17-1/4	14
B	06	500	450	1/6				5-7/8					
C	07	700	650	1/6				6-7/8					
D	08	1000	900	1/4	14	12-1/2	48-3/4	7-7/8	38-1/4	44	21-1/8	21-1/2	17-1/2
E	10	1500	1600	1/2	16	15		9-7/8					
F	12	2300	2100	1/2			11-7/8						

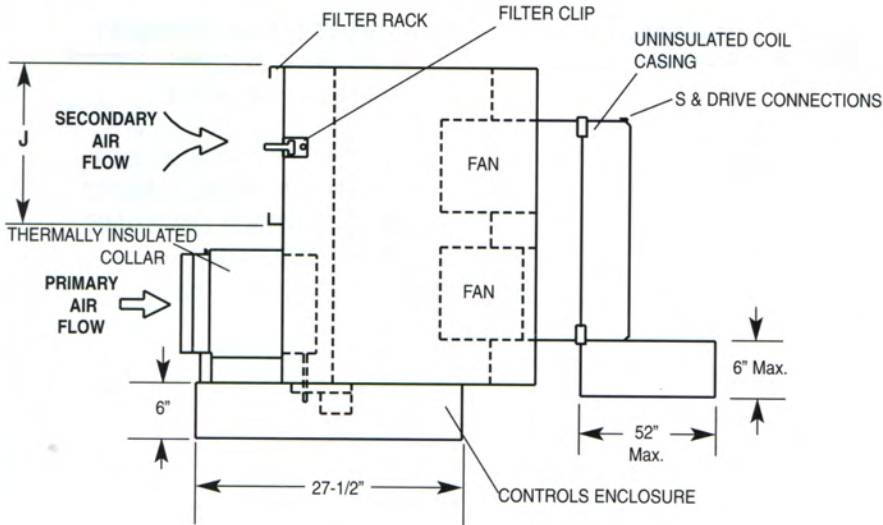

- RIGHT HAND PRIMARY AIR UNIT SHOWN. LEFT HAND AVAILABLE.
- PRIMARY AIR AND COIL CONTROL PANEL MUST BE LOCATED ON SAME SIDE OF UNIT.

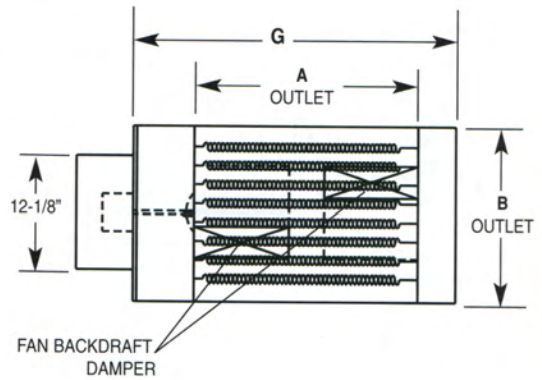
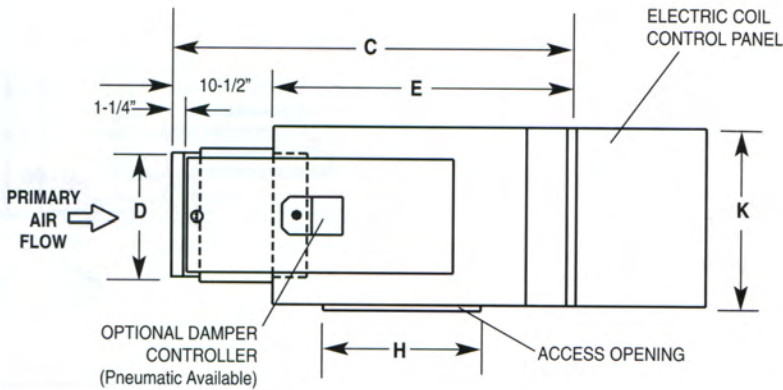

DIMENSIONS LISTED IN INCHES													
Fan Size	Inlet Size	Primary Nominal CFM	Secondary Nominal CFM @ .25" E.S.P.	Fan H.P.	Outlet		C	D	E	G	H	J	K
					A	B							
G	14	3100	3150	1/2 (2)	32	17-1/2	45-1/4	13-7/8	34-3/4	50	19-3/4	27-1/2	17-1/2
H	16	4200	3700	1/2 (2)				15-7/8					