

Model Number

Q	VC	R	A	005
Quantrol	Control Type VC = Reset variable volume with constant volume control VN = Variable volume – no constant volume control	Control Option R = Reheat (not available with Model VN) S = Standard	Design Series A	Size 005 Dia. 007 Dia. 009 Dia. 010 Dia. 714 Height x Width 820 Height x Width

Dimensions

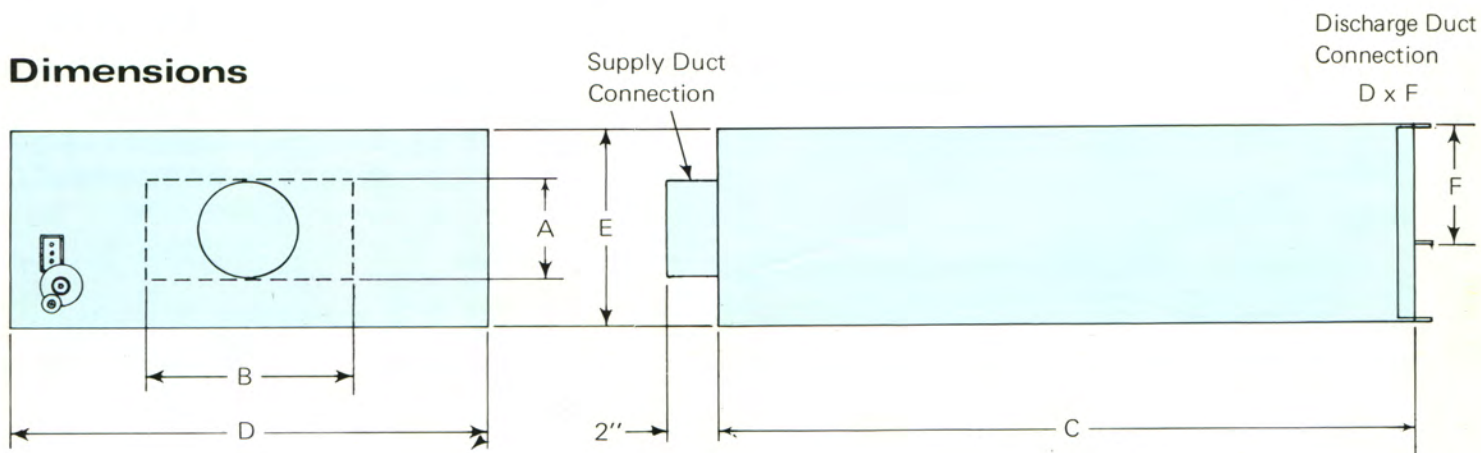

NOTES

Discharge end constructed for "S" slip and drive cleat attachment to duct by others.

Dimensions D & F show discharge duct sizes.

Dimensions D & F vary for reheat sleeve, see Accessory Dimensions.

Hanger Channels supplied by Carnes, 2 per unit.

Unit Size	Nominal CFM	A Nominal Supply Duct Connection	C	D	E	F
005	300	5 Dia.	42	17	13	5
007	600	7 Dia.	48	22	13	6
009	1000	9 Dia.	60	30	16	7
010	1500	10 Dia.	60	30	16	10
		A x B				
714	2100	7 x 14	60	32	18	12
820	3200	8 x 20	60	40	18	14

CONTROL ACCESSORIES

- Control accessories furnished are for single stage units and include primary auto reset and secondary manual reset.
- Optional control accessories available are secondary fuse links, primary mercury contactors, disconnect switch, transformer, power fusing, pressure electric interlock switch and pressure electric staging switch.

COIL FEATURES

- Grade A nickel chrome alloy resistance wire
- Aluminized steel housing
- Ceramic insulators
- Nickel-plated coil racks
- Zero clearance construction
- Meets U. L. and N. E. C. Requirements

COIL SELECTION

- After having determined box size and correct CFM, select KW from chart, not to exceed maximum shown. The selection should be based upon the minimum or reset CFM.
- Select supply voltage, control voltage and phasing.

STANDARD VOLTAGES

If you order 1 Ø or 3 Ø	You will get
110 V., 115 V., etc.	120 V.
208 V.	208 V.
220 V., 230 V., 236 V., etc.	240 V.
277 V.	277 V.
440 V., 460 V., etc.	480 V.

Ratings up to 500 V. will be furnished as ordered for custom heaters.

Electric Reheat

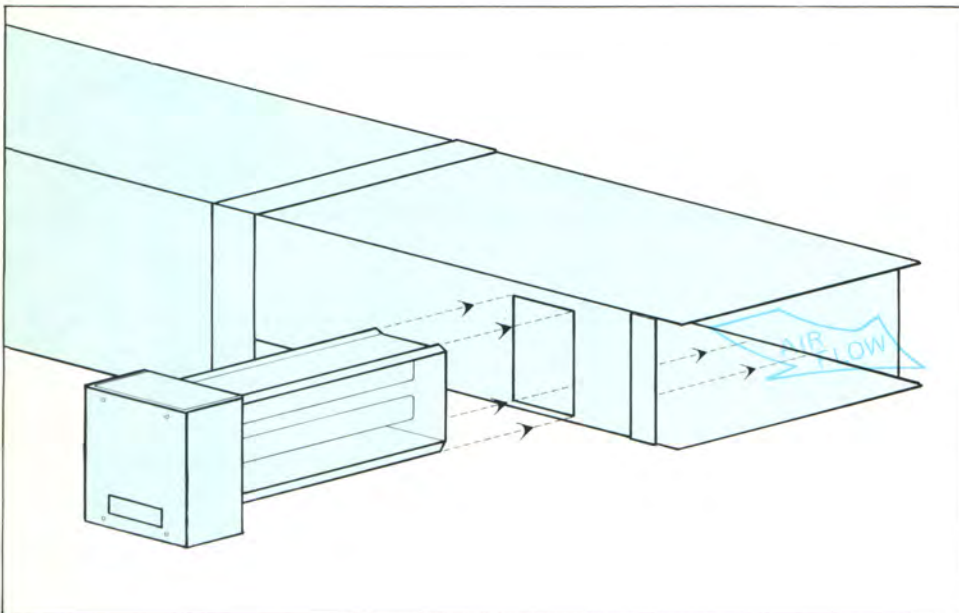

CFM/MAX. KW SCHEDULE

SIZE 005	CFM Max. KW	150 1.3	200 2.0	250 2.6	300 3.5							
SIZE 007	CFM Max. KW	150 1.2	200 1.6	250 2.7	300 3.6	350 4.5	400 5.8	450 6.5	500 7.4	600 12.0		
SIZE 009	CFM Max. KW	300 3.0	400 4.3	500 6.0	600 8.3	700 10.0	800 12.0	900 13.7	1000 20.0			
SIZE 010	CFM Max. KW	600 6.5	800 9.0	1000 16.0	1200 18.0	1400 20.5	1500 30.0					
SIZE 714	CFM Max. KW	600 5.7	800 8.1	1000 11.7	1200 16.2	1400 20.7	1600 22.5	1800 26.0	2000 30.0	2100 32.0		
SIZE 820	CFM Max. KW	1000 8.5	1400 16.0	1600 19.0	1800 25.0	2000 28.0	2200 31.0	2400 36.0	2600 39.0	2800 42.0	3000 46.0	3200 48.0

Accessory Dimensions

ELECTRIC REHEAT SLEEVE

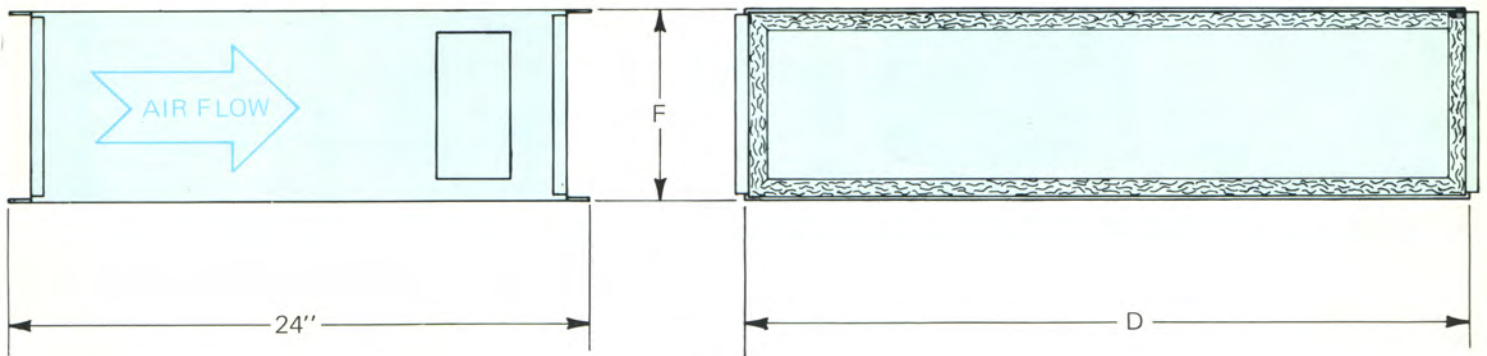

Size	F	D
005	5	6
007	5	6
009	5	6
010	5	8
714	5	10
820	6-1/8	12

MULTIPLE DISCHARGE ADAPTORS

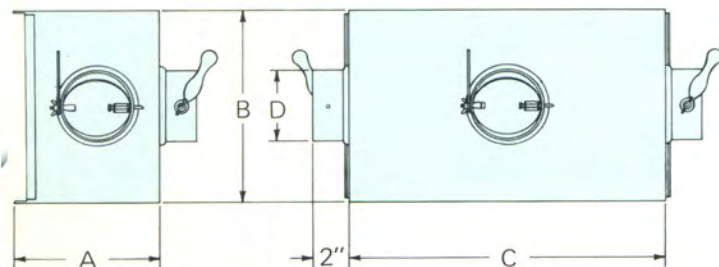

Size	A	B	C	D Dia.
005	10	13	17	6
007	10	13	22	6
009	12	16	30	8
010	14	16	30	10
714	14	16	30	10
820	16	18	40	12

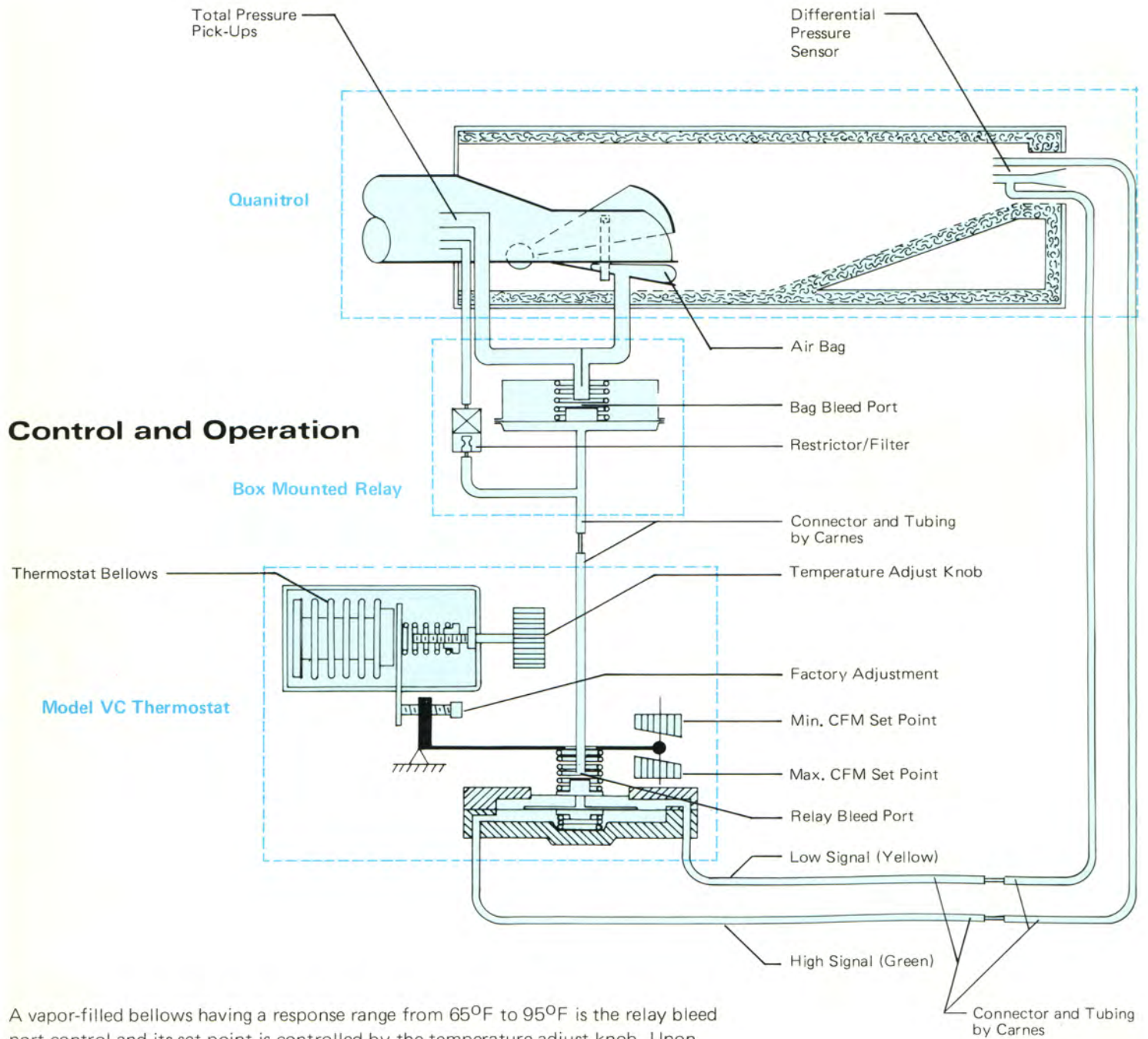

Control and Operation

A vapor-filled bellows having a response range from 65°F to 95°F is the relay bleed port control and its set point is controlled by the temperature adjust knob. Upon sensing a heat loss the bellows contract relieving the relay spring/diaphragm combination and closes the relay bleed port. Pressure may now build up thru the small restrictor/filter line, closing the bag bleed port. The large capacity total pressure pick-up now acts to inflate the air bag closing the Quanitrol valve. The minimum/maximum cams merely restrict the range thru which the relay bleed port can operate.

Constant volume is achieved by supplying differential pressure from the box discharge opening to the thermostat. Changes in air flow upset the equilibrium point, and within the maximum/minimum cam limits, open or close the relay bleed port. The bag then responds accordingly and opens upon a drop in inlet static or closes upon a rise in inlet static.

The normally open bleed port supplied with the Model VC thermostat is connected to a pressure range of 0" to .5" water gauge. It is powered by the total pressure pick-up and activated by the thermostat bellows and normally open bleed port combination.

Upon detecting a heat loss, the bellows contract, closing the bleed port. System energy now flows to the switch, closing it.

A second pressure differential switch have a 0" to 1.0" range is connected across the Quantrol velocity pressure pick-up and acts as a minimum pressure cut-out. The normally open switch is series wired with the staging switch and closes as soon as sufficient air flow occurs.

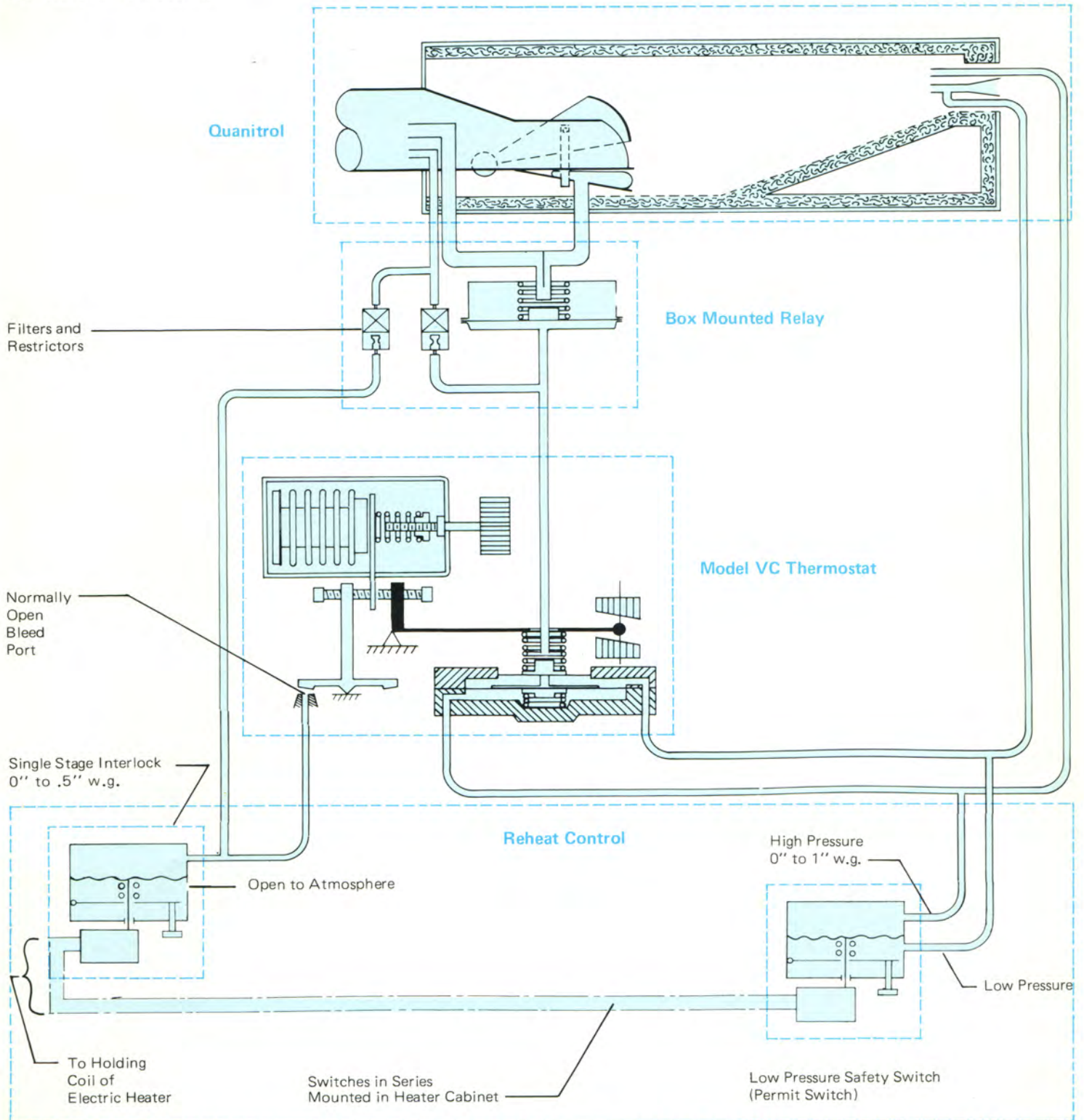

MODEL VN THERMOSTAT

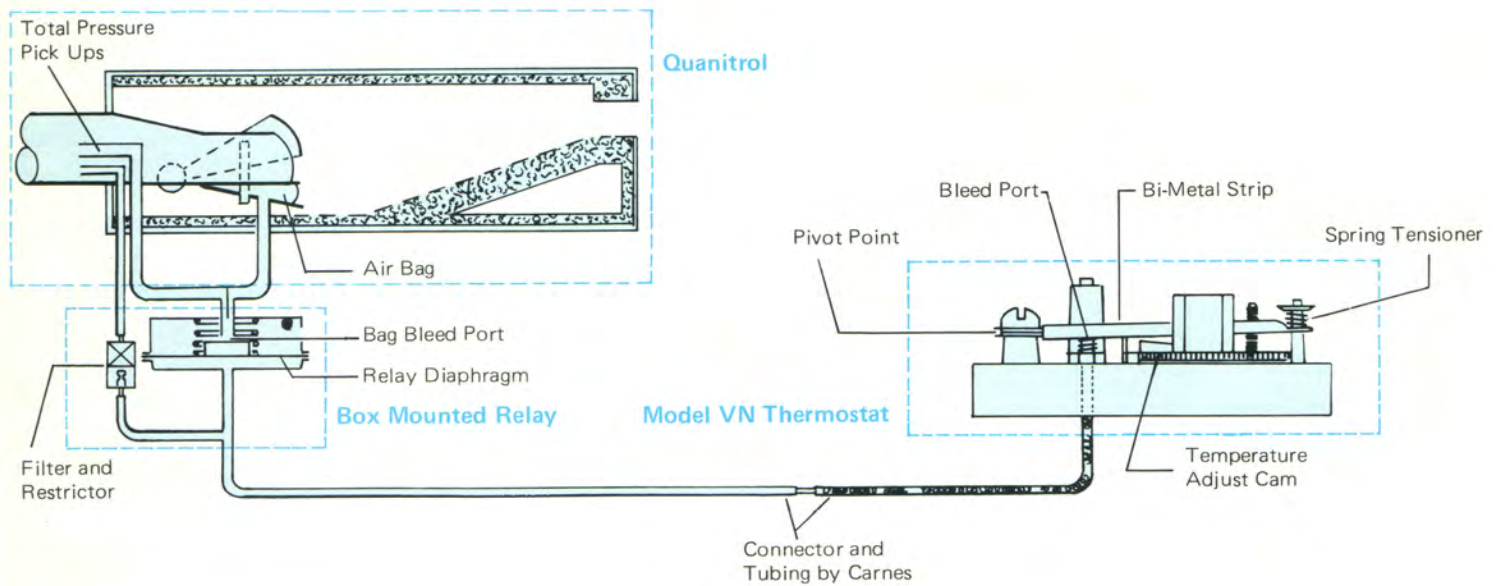

The Model VN thermostat varies the position of the Quanitrol damper in response to room air requirements. Its bi-metal strip opens or closes the bleed port, regulating the supply of air from the total pressure pick-up to the control bag.

When the thermostat senses a heat loss, the bi-metal strip acts to close the relay bleed port. In turn, the pressure builds up utilizing the filtered and restricted total pressure supply and the relay diaphragm closes the bag bleed port against the relay spring. The air bag begins to inflate utilizing the large total pressure pick-up and closes down the extruded air valve.